



GNSS-750

ANTENNA GUIDE

OM-20000120

Rev 4

September 2012

The GNSS-750 is an active antenna designed to receive signals from the GPS, Galileo and GLONASS satellites as well as L-Band signals. This antenna is designed to operate for GPS L1/L2/L2C/L5, GLONASS L1/L2/L3 and L-Band frequency bands. The GNSS-750 is also designed to operate for Galileo L1/E5a/E5b and E6 frequency bands and receives Compass B1/B2/B3. This guide provides the basic information you need to install and begin using your new antenna.

Additional Equipment Required

The following equipment is required to set up the GNSS-750:

- A sturdy pillar or mount with a 5/8" x 11 thread that extends between 3/8" and 7/8" (9 mm and 22 mm)
- Coaxial cable with a male N connector
- A device with an antenna input port that both receives the RF signal and provides 3.3 to 12.0 VDC to the antenna¹

Accessories

Additional available accessories include the following:

- A radome (NovAtel part number 01018195)

SITE SELECTION GUIDELINES

For optimal performance, select a site that meets the following conditions before installing:

- An unobstructed as possible line-of-sight from horizon to horizon and at all bearings and elevation angles.
- As far as possible from reflective objects, especially those that are above the antenna and any water bodies, which can be a strong source of multi-path reflections.
- If obstructions and reflective surfaces are within 30 m, ensure the site is as high as possible. Otherwise, mount the antenna as low as possible.

1. Most NovAtel GNSS receivers provide the necessary power through their antenna RF connectors. Check the applicable receiver user manual for details.

INSTALLING THE ANTENNA

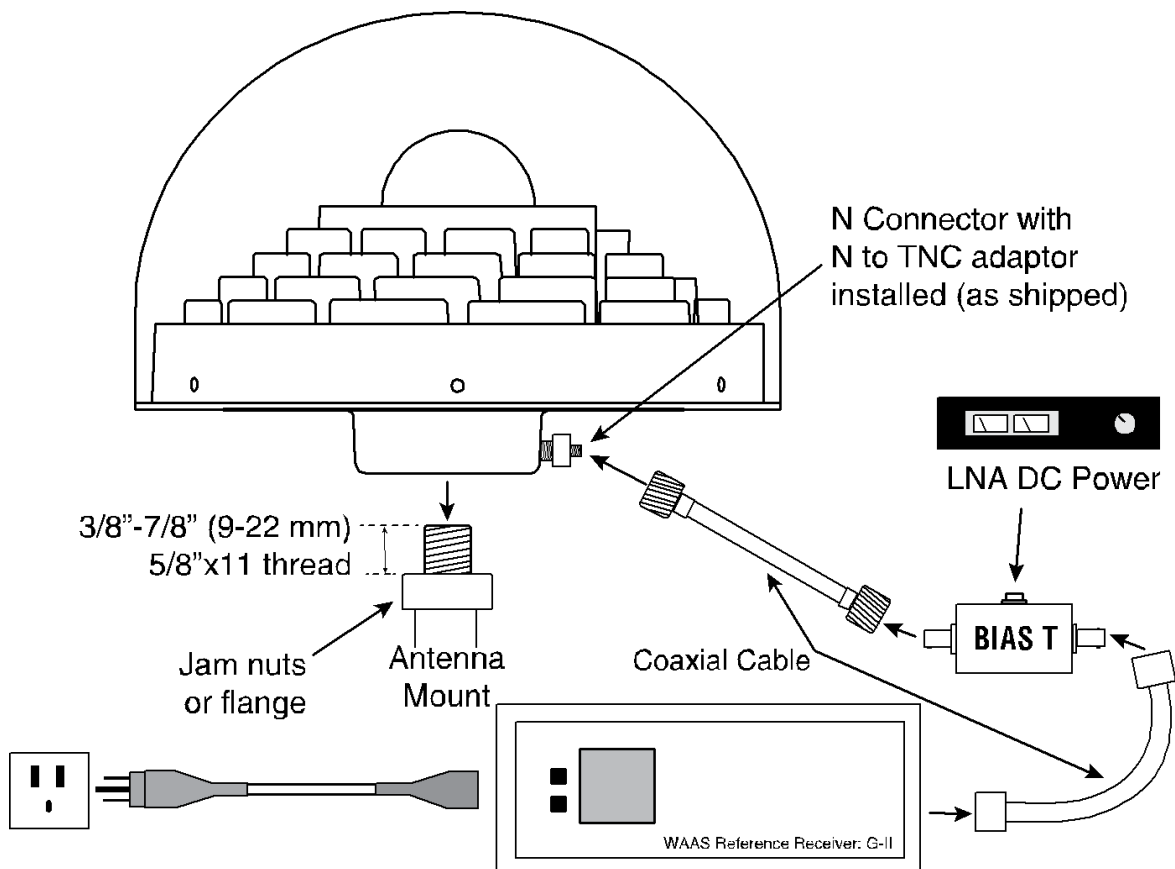

After a site has been selected, install the antenna as follows:

1. Verify that the thread on the mount does not extend more than 7/8" (22 mm) to ensure the antenna receptacle is not damaged when the mount is inserted. If it extends further than 7/8" (22 mm), add two jam nuts to shorten the exposed thread, ensuring the nuts are well tightened.
2. Align the mount thread with the metal adapter on the bottom of the antenna and rotate the antenna clockwise until it is securely screwed to the mount.
3. Remove the dust cap from the antenna's connector.
4. If attaching a TNC coaxial cable, attach the male TNC connector to the antenna's TNC connector. If attaching a N connector coaxial cable, remove the N to TNC adaptor and attach the male N connector of the coaxial cable to the antenna's N connector.
5. Attach the other end of the coaxial cable to the antenna input port of the receiving device, which must provide power as detailed in the , *Specifications* section of this guide.

ANTENNA CARE

The GNSS-750 is designed to withstand the elements, including rain, snow, and dust. However, to ensure your antenna performs optimally, keep the top surface and the choke rings of the antenna clean and brush off any ice and snow. A radome is recommended. In addition, ensure the N connector remains clean and dry and replace the dust cap when a cable is not connected.

ELEVATION GAIN PATTERNS

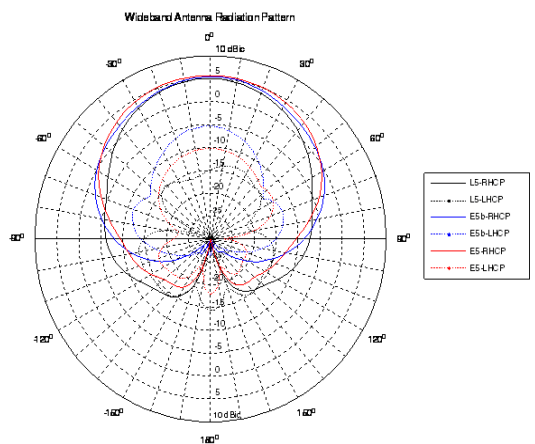
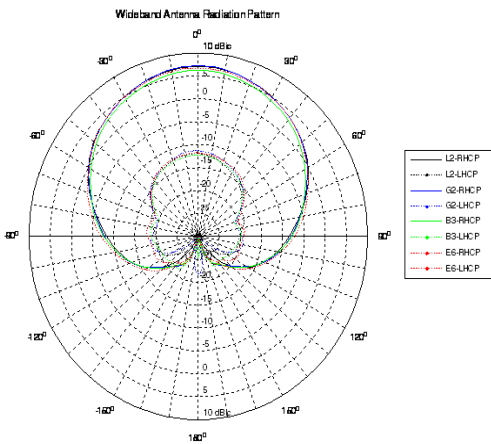
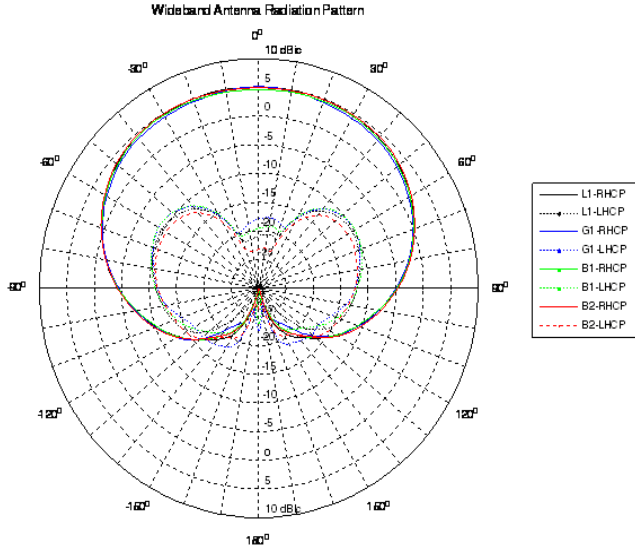



SPECIFICATIONS

RF	
3 dB pass band (typical)	Upper:1525-1612 MHz Lower:1164-1301 MHz
Out-of-band rejection (typical)	
0 ~ 900	80 dB
900 ~ 1002.5 MHz	70 dB
1002.5 ~ 1062.5 MHz	50 dB
1062.5 ~ 1102.5 MHz	30 dB
1370 ~ 1465 MHz	30 dB
1410 ~ 1440 MHz	50 dB
1668 ~ 1718.5 MHz	30 dB
1718.5 ~ 1798.5 MHz	50 dB
1798.5 ~ 1900 MHz	70 dB
1900 ~ 3000 MHz	80 dB
Gain at zenith ($\theta = 90^\circ$) (min)	+5 dBic
Gain roll-off (zenith to horizon)	10-15 dB
LNA gain (typical)	39 ± 3 dB
Polarization	Right-hand circular
Noise figure (typical)	1.5 dB
Differential propagation delay (maximum)	9 ns
Nominal impedance	50 Ω
VSWR	$\leq 1.5 : 1$
POWER	
Input voltage	3.3 - 12 V
Current (typical)	70 mA
PHYSICAL	
Diameter	380 mm (14.96")
Weight	7.6 kg (317.47 oz)
Height	200 mm (7.48")
ENVIRONMENTAL	
Operating temperature	-55°C to +85°C (-67°F to
Storage temperature	-55°C to +90°C (-67°F to
Salt spray	MIL-STD-810F Method 509.4
Ingress protection	IPX6 and IPX7

MECHANICAL DRAWINGS

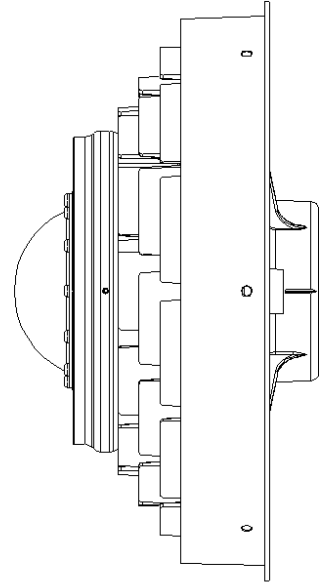
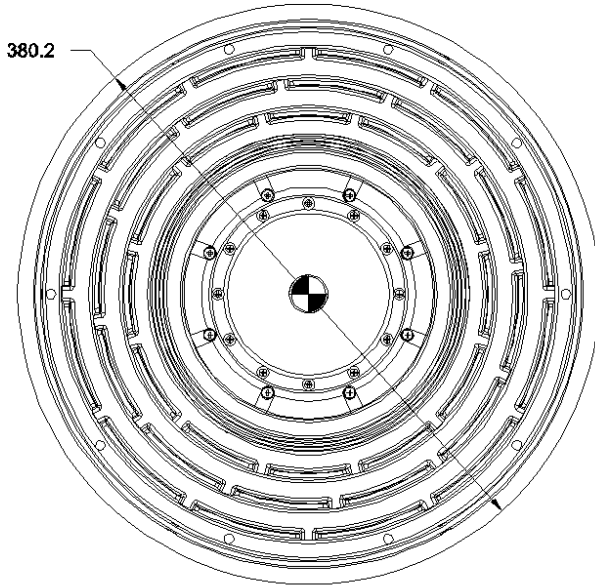
All dimensions are in millimetres (mm) where 1 inch = 25.4 mm.



 = Phase center

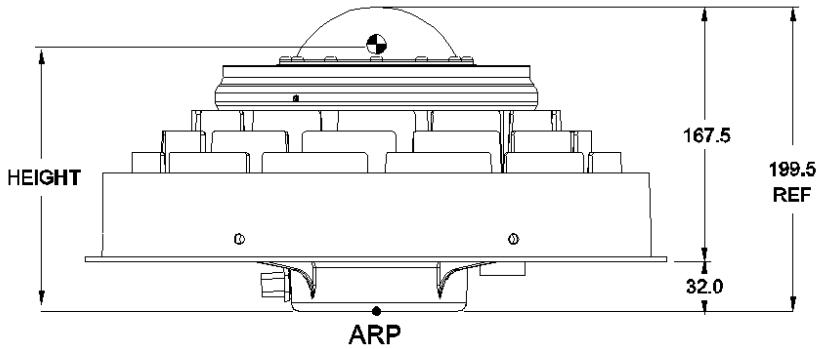

PHASE CENTER

Please see the , *Mechanical Drawings* section on the previous panel and the close up of the label below before reading this section.

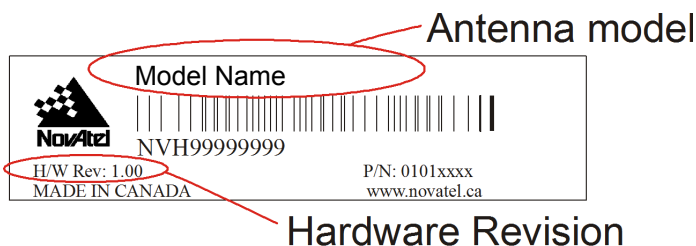

For absolute offset numbers and to download PCV (Phase Center offsets and Variations) tables, please visit the GEO++ Web site at www.geopp.com.

When using the Web site mentioned above, look for the NovAtel listing of your antenna model **and** its hardware revision.



Only integer hardware revisions affect the phase center offsets. For example, the numbers given for hardware revision 2.02 are applicable to an antenna labelled H/W Rev: 2.00, 2.05, 2.12 and so on.

Table 1 shows typical absolute and relative offset numbers for the current 750 antenna model.

Table 1: Height

	Absolute (GEO++) with Radome	Absolute (GEO++) without Radome
L1	170 mm	162 mm
L2	157 mm	159 mm

If you need any further advice on this matter, please visit our Web site at www.novatel.com. Other methods of contacting Customer Support can be found on the last panel of this guide.

Warranty Policy

NovAtel Inc. warrants that its Global Positioning System (GPS) products are free from defects in materials and workmanship, subject to the conditions set forth below, for the following periods of time:

GPSAntenna™ Modules:One (1) Year

Cables and Accessories:Ninety (90) Days

Date of sale shall mean the date of the invoice to the original customer for the product. NovAtel's responsibility respecting this warranty is limited solely to product repair at an authorized NovAtel location only.

Determination of repair will be made by NovAtel personnel or by technical personnel expressly authorized by NovAtel for this purpose.

The foregoing warranties do not extend to

(i) nonconformities, defects or errors in the products due to accident, abuse, misuse or negligent use of the products or use in other than a normal and customary manner, environmental conditions not conforming to NovAtel's specifications, or failure to follow prescribed installation, operating and maintenance procedures,

(ii) defects, errors or nonconformities in the products due to modifications, alterations, additions or changes not made in accordance with NovAtel's specifications or authorized by NovAtel, (iii) normal wear and tear, (iv) damage cause by force of nature or act of any third person, (v) shipping damage; or (vi) service or repair of product by the dealer without prior written consent from NovAtel.

In addition, the foregoing warranties shall not apply to products designated by NovAtel as beta site test samples, experimental, developmental, preproduction, sample, incomplete or out of specification products or to returned products if the original identification marks have been removed or altered.

The warranties and remedies are exclusive and all other warranties, express or implied, written or oral, including the implied warranties of merchantability or fitness for any particular purpose are excluded.

NovAtel shall not be liable for any loss, damage or expense arising directly or indirectly out of the purchase, installation, operation, use or licensing of products or services. In no event shall NovAtel be liable for special, indirect, incidental or consequential damages of any kind or nature due to any cause.

There are no user-serviceable parts in the GPS Antenna and no maintenance is required. If the unit is faulty, replace with another unit and return the faulty unit to NovAtel Inc. You must obtain a RETURN MATERIAL AUTHORIZATION (RMA) number by calling NovAtel Customer Support at 1-800-NOVATEL (U.S. and Canada only) or 403-295-4900 before shipping any product to NovAtel or a dealer. Once you have obtained an RMA number, you will be advised of proper shipping procedures to return any defective product. When returning any product to NovAtel, please return the defective product in the original packaging to avoid damage.



Before shipping any material to NovAtel or Dealer, please obtain a Return Material Authorization (RMA) number from the point of purchase or NovAtel's Customer Support.

WEEE Notice

If you purchased your GNSS-750 in Europe, please return it to your dealer or supplier at the end of its life. The objectives of the European Community's environment policy are, in particular, to preserve, protect and improve the quality of the environment, protect human health and utilise natural resources prudently and rationally. Sustainable development advocates the reduction of wasteful consumption of natural resources and the prevention of pollution. Waste electrical and electronic equipment (WEEE) is a regulated area. Where the generation of waste cannot be avoided, it should be reused or recovered for its material or energy. WEEE products may be recognized by their wheeled bin label.

Questions or Comments

If you have any questions or comments regarding your GNSS-750, please contact NovAtel Customer Support using one of methods provided below.

E-mail: support@novatel.com

Web: www.novatel.com

Phone: 1-800-NOVATEL (International) or 403-295-4900 (U.S. & Canada)

Fax: 403-295-4901



© Copyright 2012 NovAtel Inc. All rights reserved.
Unpublished rights reserved under international copyright laws.

Recyclable

